

# Woven Air

INSTRUCTIONS FOR USE MANUAL



WOVEN AIR CUSHION



SPRINT CUSHION















WOVEN AIR INSERTS

By **ROLAPAL**



## CONTENTS

Items Discussed in Manual	3
Product Specifications	3
Items Included in the Package	4
Accessories	5
Cushion Sizing and Tube Specifications	7
Intended Use	8
Caution - Risks Identified	8
Disclaimers	8
Installation Instructions	9
Fitting the Cushion to the User	10
Knowing Your Woven Air Cushion	11
Air Tube Weave Patterns	13
Care Instructions	14
Troubleshooting	15

## SYMBOLS

	Identifies products that meet the requirements of Regulation 2017/745 / EU on medical devices		Batch code
	Indicates that a product is a medical device		Catalogue number
	Shows the manufacturer of the medical device		Date of manufacture
	WC20 & ISO7176-19 certified for forward facing use in a motor vehicle		Authorized representative in the European Community
	Product Weight (kgs)		Consult instructions for use
	Max User Weight (kgs)		Warnings
	Product Dimensions		



## Items Discussed in Manual

	<p><b>WOVEN AIR CUSHION</b></p> <p>The Woven Air cushion is segmented into 4 zones allowing the air to flow freely within each zone promoting positioning and pressure redistribution. 55mm height under user.</p>
	<p><b>WOVEN AIR SPRINT CUSHION</b></p> <p>The Woven Air Sprint Cushion is an ultra-lightweight, slim cushion that features a stable closed-cell foam base. It provides extra support under the thighs and incorporates Woven Air technology in the ischial region, making it an excellent choice for self-propelling users.</p>
	<p><b>WOVEN AIR INSERTS FOR G7 and STX2 CUSHIONS</b></p> <p>Woven Air inserts are designed to fit in the Ischial well of Dreamline G7 and STX2 cushions as an alternative to the Gel Cluster Packs.</p>

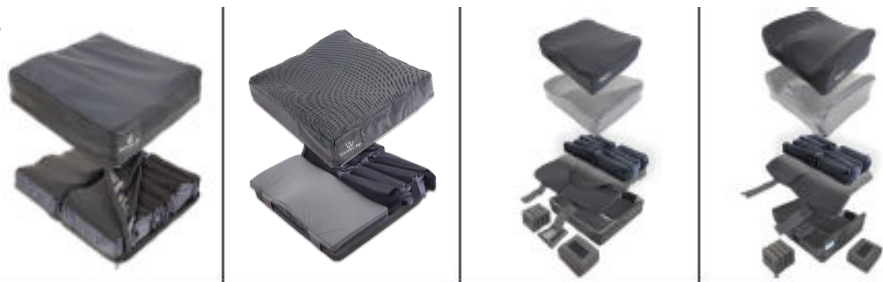
### Product Specifications

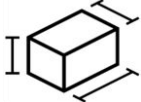

	PRESSURE SERIES			
	Woven Air	Sprint	G7	STX2
CODE	WACxxxx	WSCxxxx	D7CWxxxx	DX2CWxxxx
CUSHION COMPOSITION	Air	Foam and Air	Foam and Air	
WIDTH	14" - 20" (36cm - 51cm)		14" - 20" (36cm - 51cm)	
DEPTH	14" - 22" (36cm - 56cm)		14" - 22" (36cm - 56cm)	
*AVERAGE CUSHION WEIGHT	1.2kg (2.65lbs)	0.9kg (1.98lbs)	1.6kg (3.53lbs)	1.9kg (4.19lbs)
HEIGHT UNDER USER*	55mm	65mm	85mm	
USER WEIGHT LIMIT	180kg / 397lb		136kg / 300lb	

ITEM			
<b>Woven Air Cushion</b>	Up to 2 kg	180kg	51cm x 56cm x 10cm
<b>Woven Air Sprint Cushion</b>	Up to 1.8 kg	180kg	51cm x 56cm x 10cm
<b>STX2 with Woven Air</b>	Up to 2.7 kg	136kg	51cm x 56cm x 16cm
<b>G7 with Woven Air</b>	Up to 2.7 kg	136kg	51cm x 56cm x 10cm

## INCLUDED IN THIS PACKAGE

### Woven Air Cushion

1. Outer Cover
2. Inner Air Pocket
3. Air Tubes (see table below for quantities)



### Woven Air Sprint Cushion

1. Outer Cover
2. Thigh Pad
3. Inner Air Pocket
4. Air Tubes (see table below for quantities)
5. Contour Base



### G7 / STX2 Woven Air Insert

1. Inner Air Pocket
2. Air Tubes (see table below for quantities)



Cushion Inner Materials: Nylon/Urethane tubes, Polyester/Nylon/Urethane Air Pocket (made without latex)

Cushion Cover Materials: Refer to the care label on the cover

## ACCESSORIES

**WOVEN AIR CONTOUR AND ADJUSTABLE BASES** – Adds gentle contouring to the cushion for increased stability and offloading.

Woven Air contour base is an accessory for the Woven Air cushion only, the Woven Air Sprint comes standard with a contour base. Adjustable base is an accessory for both the Woven Air and Woven Air Sprint Cushion



WAC1414CB	WAC1416CB	WAC1418CB	WAC1515CB	WAC1516CB
WAC1517CB	WAC1616CB	WAC1618CB	WAC1620CB	WAC1717CB
WAC1719CB	WAC1816CB	WAC1818CB	WAC1820CB	WAC1822CB
WAC1919CB	WAC2018CB	WAC2020CB	WACCUSTCB	WACCUSTXLCB



WAC1414AB	WAC1416AB	WAC1418AB	WAC1515AB	WAC1516AB
WAC1517AB	WAC1616AB	WAC1618AB	WAC1620AB	WAC1717AB
WAC1719AB	WAC1816AB	WAC1818AB	WAC1820AB	WAC1822AB
WAC1919AB	WAC2018AB	WAC2020AB	WACCUSTAB	WACCUSTXLAB

**EXTRA WOVEN AIR TUBES** - Woven Air Tubes for Woven Air Cushion and Woven Air Sprint Cushion



CODE	DESCRIPTION	TUBE LENGTH (mm)	QTY
WAT1470	Woven Air Tube 14" x 70mm (for Sprint/Woven Air Cushions)	870	4pk
WAT1570	Woven Air Tube 15" x 70mm (for Sprint/Woven Air Cushions)	930	4pk
WAT1670	Woven Air Tube 16" x 70mm (for Sprint Cushions)	990	4pk
WAT1770	Woven Air Tube 17" x 70mm (for Sprint Cushions)	1050	4pk
WAT1870	Woven Air Tube 18" x 70mm (for Sprint Cushions)	1110	4pk
WAT1970	Woven Air Tube 19" x 70mm (for Sprint Cushions)	1150	4pk
WAT2070	Woven Air Tube 20" x 70mm (for Sprint Cushions)	1200	4pk
WAT70CUSTXL	Woven Air Tube from 22" x 70mm (for Sprint Cushions)	up to 1400	4pk
WAT1690	Woven Air Tube 16" x 90mm (for Woven Air Cushions)	990	4pk
WAT1790	Woven Air Tube 17" x 90mm (for Woven Air Cushions)	1050	4pk
WAT1890	Woven Air Tube 18" x 90mm (for Woven Air Cushions)	1100	4pk
WAT1990	Woven Air Tube 19" x 90mm (for Woven Air Cushions)	1150	4pk
WAT2090	Woven Air Tube 20" x 90mm (for Woven Air Cushions)	1200	4pk
WAT90CUSTXL	Woven Air Tube from 22" x 90mm (for Woven Air Cushions)	up to 1400	4pk

Woven Air Tubes for STX2/G7 Air Cushions

CODE	DESCRIPTION	TUBE LENGTH (mm)	QTY
WAT1460	Woven Air Tube 14" x 60mm (for STX2/G7 Cushions)	750	4pk
WAT1560	Woven Air Tube 15" x 60mm (for STX2/G7 Cushions)	810	4pk
WAT1660	Woven Air Tube 16" x 60mm (for STX2/G7 Cushions)	870	4pk
WAT1760	Woven Air Tube 17" x 60mm (for STX2/G7 Cushions)	930	4pk
WAT1860	Woven Air Tube 18" x 60mm (for STX2/G7 Cushions)	990	4pk
WAT1960	Woven Air Tube 19" x 60mm (for STX2/G7 Cushions)	1050	4pk
WAT2060	Woven Air Tube 20" x 60mm (for STX2/G7 Cushions)	1110	4pk
WAT60CUSTXL	Woven Air Tube from 22" x 60mm (for STX2/G7 Cushions)	up to 1200	4pk

**CUSHION RIGID BASE** – Attaches with hook directly to the reciprocal loop on the underside of the cushion inner.



DCRB1414	DCRB1416	DCRB1418	DCRB1515	DCRB1517
DCRB1519	DCRB1616	DCRB1618	DCRB1620	DCRB1717
DCRB1719	DCRB1816	DCRB1818	DCRB1820	DCRB1822
DCRB1919	DCRB2018	DCRB2020	DCRBCUST	DCRBCUSTXL

**PELVIC OBLIQUITY PADS** – attaches with hook directly to the reciprocal loop on the underside of the cushion inner.



This accessory can be used with the Woven Air cushion and Woven Air Sprint cushion.

(Set of 4)

DCOP14	DCOP16	DCOP18	DCOP20
--------	--------	--------	--------

**PELVIC OBLIQUITY PAD SIZING CHART - WOVEN AIR AND SPRINT CUSHIONS**

CUSHION (shortest width or length of cushion)	14"	16"	18"	20"
PAD WIDTH / LENGTH (mm)	160x160	185x185	210x210	235x235
PAD HEIGHT (mm)	10	10	10	10
CODE (Set of 4)	DCOP14	DCOP16	DCOP18	DCOP20

Custom pads available, use code - DCOPCUST

**OUTER COVERS AND INNER COVERS**



Outer Cover only add "OC" to end of desired cushion code

Inner Cover only add "IC" to end of desired cushion code

## CUSHION SIZING AND TUBE SPECIFICATIONS

CUSHION SIZE	WOVEN AIR CUSHION CODE	AIR TUBES INSIDE WOVEN AIR CUSHION (each cushion also has 2 extra spare tubes)	WOVEN AIR SPRINT CUSHION CODES	AIR TUBES INSIDE WOVEN AIR SPRINT CUSHION (each cushion also has 2 extra spare tubes)
14X14	WAC1414	16	WSC1414	8
14X16	WAC1416	16	WSC1416	8
14X18	WAC1418	16	WSC1418	8
15X15	WAC1515	16	WSC1515	8
15X16	WAC1516	16	WSC1516	8
15X17	WAC1517	16	WSC1517	8
16X16	WAC1616	16*	WSC1616	8
16X18	WAC1618	16*	WSC1618	8
16X20	WAC1620	20*	WSC1620	10
17X17	WAC1717	16*	WSC1717	8
17X19	WAC1719	16*	WSC1719	8
18X16	WAC1816	16*	WSC1816	8
18X18	WAC1818	16*	WSC1818	8
18X20	WAC1820	20*	WSC1820	10
18X22	WAC1822	20*	WSC1822	10
19X19	WAC1919	20*	WSC1919	10
20X18	WAC2018	20*	WSC2018	10
20X20	WAC2020	20*	WSC2020	10

\* Uses 90mm high Air Tubes (the rest use 70mm high air Tubes)

G7 / STX2 WOVEN AIR INSERT CODES	AIR TUBES INSIDE G7 / STX2 CUSHION (each cushion also has 2 extra spare tubes)
WAI1414	6
WAI1416	6
WAI1418	6
WAI1515	6
WAI1516	6
WAI1517	6
WAI1616	6
WAI1618	6
WAI1620	8
WAI1717	6
WAI1719	6
WAI1816	6
WAI1818	6
WAI1820	8
WAI1822	8
WAI1919	8
WAI2018	8
WAI2020	8

\* Uses 60mm high Air Tubes

## INTENDED USE

Woven Air technology is intended to be used as an air flotation support surface. The Air Tubes in these items, are designed to immerse and conform to the user when properly sized to the individual, assisting in pressure redistribution and comfort to the user.

If there are any questions about product installation or compatibility with the wheelchairs, ROLAPAL customer service should be consulted.

**CONTRAINDICATION:** This should be determined by the experienced prescriber. This item should be used in conjunction with comprehensive care plan.



### CAUTION - RISKS IDENTIFIED

- Removal of Air Tubes – ensure there is enough air under the user, so the user does not penetrate through the cushion, risk of pressure injury.
- Adding Air Tubes – if there is too much air in the cushion it becomes firm and does not enable the occupant to immerse properly. Risk of increasing pressure.
- Due to the adjustable nature of this cushion, when reconfiguring, take care to ensure the desired outcome is achieved for the occupant.
- Keep away from heaters and open flame – risk of damage.
- Take care when leaving this cushion in direct sunlight. Parts may heat up and increase risk of burns to the occupant.
- When using a solid seat base, the cushion must overhang the front edge by at least ½” (13mm) to protect against skin damage occurring from the seat base front edge.
- Do not use the cushion if the occupant’s weight is more than the maximum recommended user weight of the cushion.
- An incorrectly fitted cushion can cause potential harm to the user. Carefully read the fitting instructions for correct positioning and orientation of the cushion on the wheelchair.

## REPORTING OF INCIDENTS

All serious incidents occurring in relation to the product must be reported to ROLAPAL Ltd and your competent authority!

## DISCLAIMER

Because of the adjustability of the cushion, Rolapal accepts no responsibility for the therapeutic outcome for the occupant. This is the responsibility of the prescribing seating therapist or technician.

## REUSABILITY

The product is suitable for reuse. The reuse handover takes place after the product has been checked by the specialist trade.

## SPECIAL STORAGE/HANDLING CONDITIONS

Do not store in environments above 50°. Do not store close to uninsulated roofs to avoid direct or indirect heat.

## PRODUCT LIFE EXPECTANCY

This item is expected to last between 2 – 5 years under normal use but this can change dramatically between users depending on the length of time in use, environment and weight of the user.

## END OF LIFE RECYCLING

At the end of its useful life, the entirety of the cushion is general waste disposal.

## GUARANTEE

Woven Air Cushions are manufactured to a very high standard and carry a guarantee against defects in materials and craftsmanship for a period of 18 months under normal use.

Any item found to be defective will be repaired or replaced at the discretion of Rolapal Ltd.

Goods must be returned to Rolapal Ltd for assessment and the new repaired or replaced item will be sent free of charge. This guarantee does not cover items which are damaged from general “wear and tear”, misuse or negligence.

## INSTALLING YOUR WOVEN AIR CUSHION ONTO THE WHEELCHAIR

### ATTACHMENT

The cushion is designed to attach to the wheelchair with hook/loop attachment directly to the seat base or slung upholstery of the wheelchair or to a separate fitted seat base.

Check the cushion fits the wheelchair frame. If the cushion is too narrow it may move around on the wheelchair frame. The cushion should fit snugly between the arm supports of the wheelchair (to the outside edges of the seat rails of the wheelchair).

Check the length of the cushion fits the length of the wheelchair. If the cushion is too short the base of the wheelchair may be exposed putting the user at risk.

If the sling upholstery seat base of the wheelchair causes the cushion to “hammock” use a lightweight Dreamline Cushion Rigid base. The Dreamline rigid base attaches via hook and loop directly to the underside of the cushion foam inner.

### ORIENTATION

The “Care” labels on the cushion inner and covers mark the rear bottom of the cushion. The soft stretchy surface of the cushion and covers is the top surface.

The sides of the cushion must be installed parallel to the seat rails of the wheelchair.

Top Front of cushion



## FITTING THE CUSHION TO USER

Before fitting, check the size of the cushion suits the user. The cushion must fully support the base of the user. Woven Air™ cushions have the best pressure management effect if the cushion dimensions are closer to the dimensions of the user.

If the user has a leg length discrepancy, use the Woven Air Sprint cushion, G7 Cushion or STX2 Cushion with Woven Air Insert and apply the leg length discrepancy modification for accommodating the discrepancy. (Please note: The full Woven Air Cushion cannot be modified).

Ensure the length from the top surface of the cushion to the top surface of the footplate wheelchair is set up correctly for the user. The left side may be different to the right side so both need to be measured individually. The lower leg length should be set up so that the front of the cushion lightly takes the weight of the user.

Use the positioning pads to accommodate or correct pelvic asymmetries. They can be set up according to the wishes of the prescribing therapist to asymmetrically change the contours of the cushion. i.e., to increase the pre-ischial shelf, correct pelvic obliquity etc.

**NOTE: It is preferable to use positioning pads to correct or accommodate asymmetries rather than adjusting the air cells as adjusting the air cells may compromise the pressure redistribution effect of the cushion.**

## ADJUSTING WOVEN AIR CUSHIONS

Woven Air Cushions and inserts are despatched from factory with a predetermined quantity of “Air Tubes” installed on the cushion (they can be found in the table on page 5).

Sometimes it is necessary to adjust the cushion pressure redistribution depending on the fit of the user to the cushion. The Woven Air cushion range are adjustable by adding and removing an Air Tube.

For the Woven Air cushion remove the outer cover then unzip the inner exposing the “Air Pocket” containing the “Air Tubes”. Note the Woven Air Sprint cushion does not have an inner cover.

## KNOWING YOUR CUSHION

1. **Air Tubes** – these contain a prefilled amount of air in each tube.

**Each Air Tube has a seam running along the length. During installation, the preference is for the seam to face downwards so it does not come in contact with the occupant.**

Numerals are printed at one end on each tube. The first 2 digits refer to the width of the cushion it will fit in inches (i.e. all 18” wide cushions.)

The second 2 digits refer to the height of the tube in mm (i.e. 90 = 90mm high)

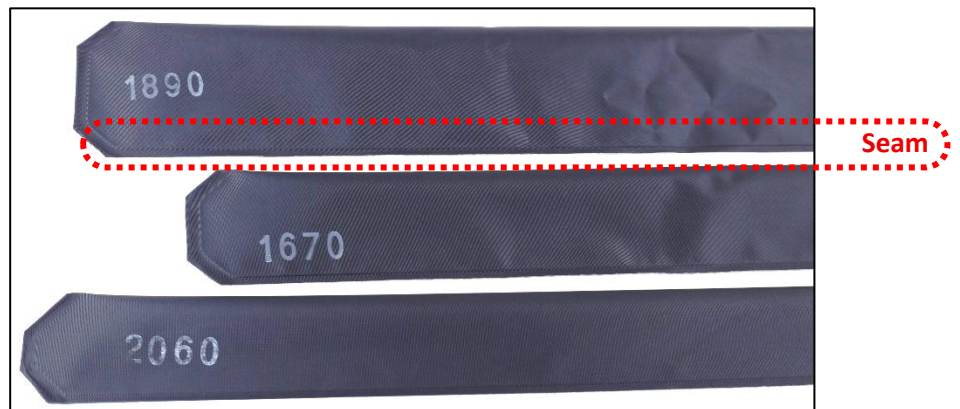

Each “Air Tube” has a heat pressed oval in the centre.

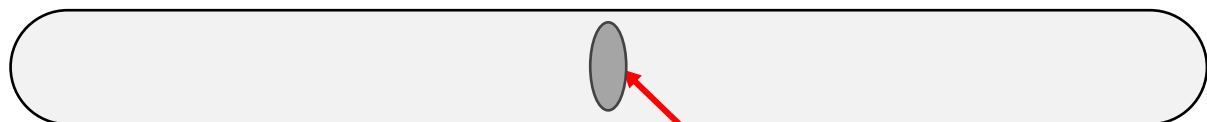

2. **Air-Pocket** – the Air Pocket is the cushion inner of the Woven Air cushion which contains the “Air Tubes”. The “Air Pocket” is separated into left and right sections.



The underside of the Air-pocket is hook receptive loop fabric. This enables the use of positioning pads to be attached such as the contour base and pelvic obliquity pads.

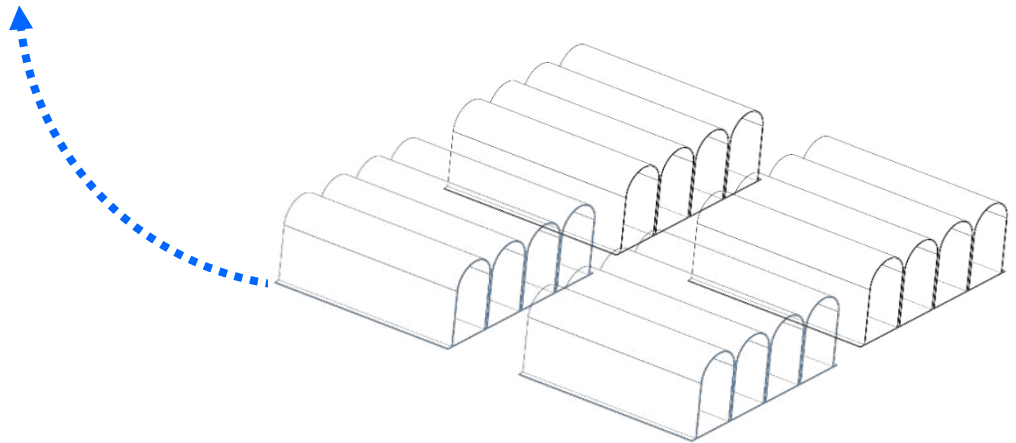

Woven Air Cushion

With each Woven Air cushion (and Sprint Cushions 18x22, 20x22), the left and right section of the Air-Pocket contains 2 zones with 8 pockets. All other Sprint cushion sizes and Woven Air Inserts for G7/STX2 cushions have single zone with 4 pockets on each side (shown below).



Sprint Cushion



G7 / STX2 Woven Air Insert

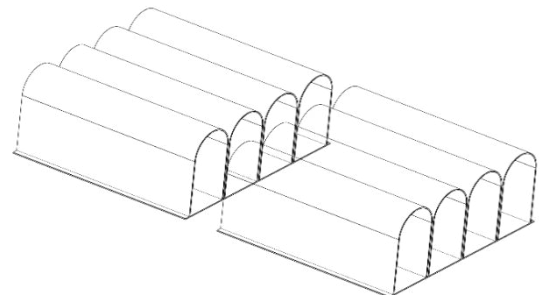

**Option 1 – “W” Weave Pattern (best pressure dispersion):**

Each Air Tube weaves through 4 pockets so that the air from each Air Tube covers that section of the cushion. The weave pattern is shown below. The oval at the centre of each tube marks the centre point and faces the outside edge of the cushion between 2<sup>nd</sup> and 3<sup>rd</sup> pockets.

When adding more “Air Tubes” feed the first end of the “Air Tube” into pocket 1 then out through pocket 4 and then feed the 2<sup>nd</sup> end of the “Air Tube” into pocket 2 and out through pocket 3.

NOTE: Cushions are dispatched as standard with this weave pattern.

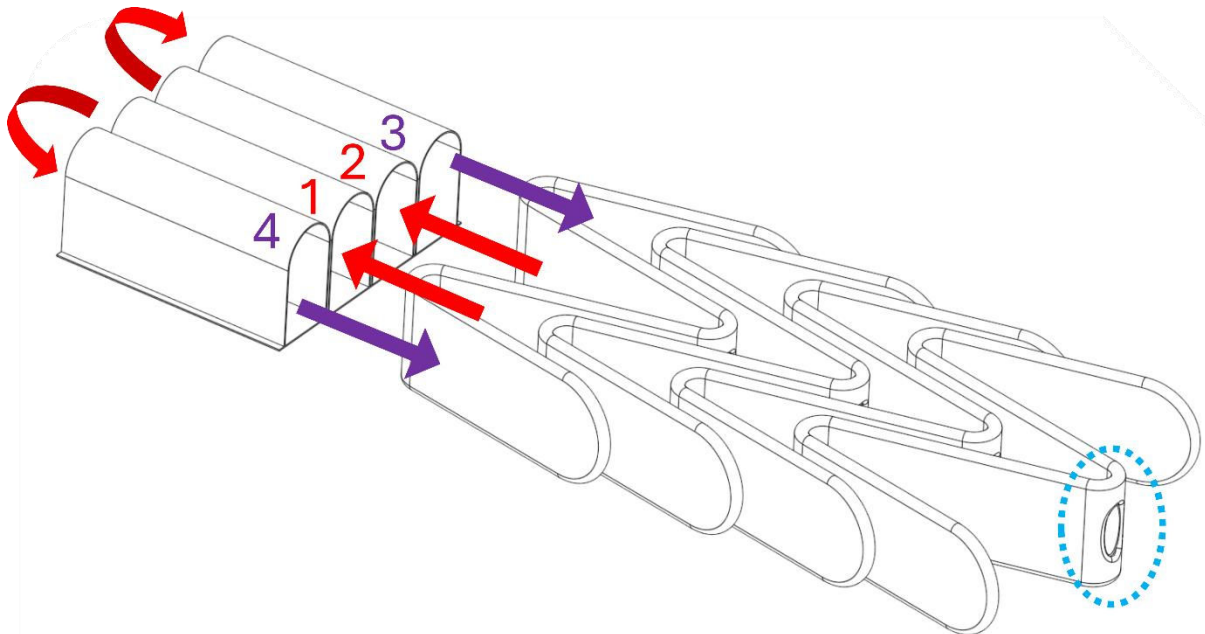

**Option 2 – “V” Weave Pattern (Reduced Air dispersion):**

This weave pattern is useful to limit the rearward dispersion of air particularly for instances where the user may not be utilizing the full surface area. It encapsulates the air in smaller zones reducing the possibility of bottoming out.

First fold the tube at the centre “oval” position and thread pairs of tubes through 2 pockets instead of 4.

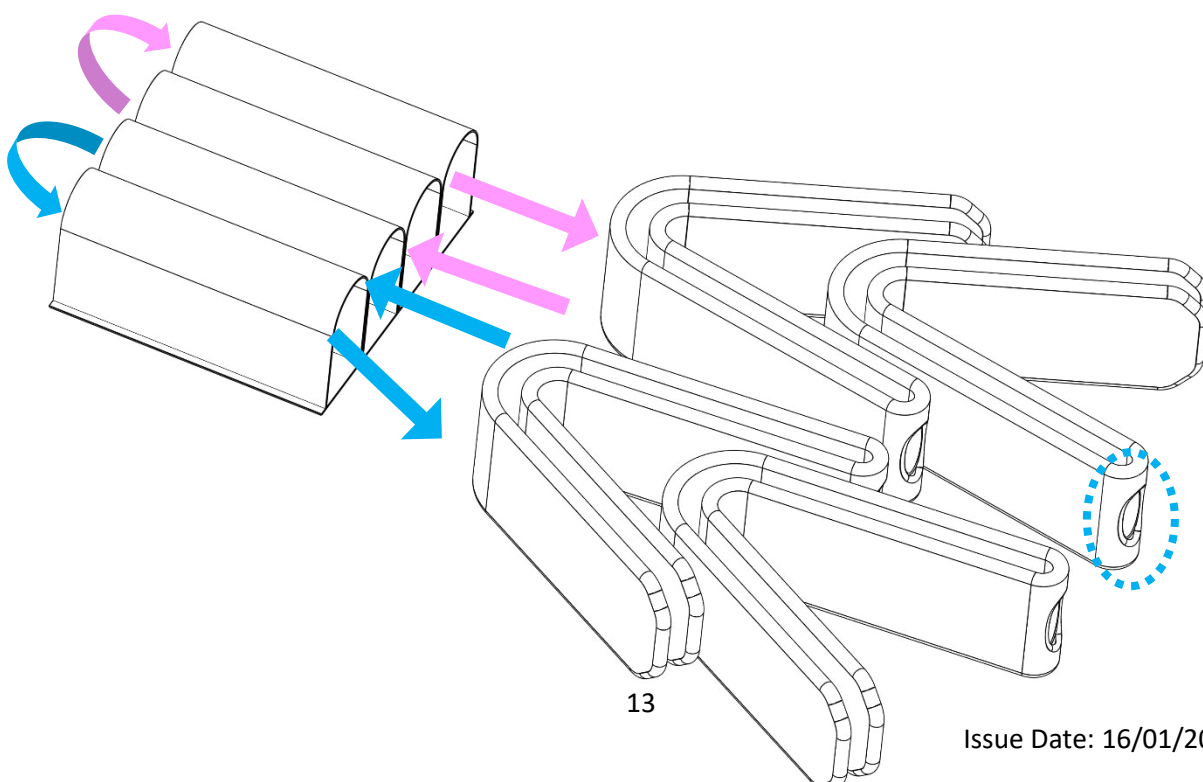

Do not overlap the “Air Tubes”, ensure they are placed side by side as per the below “top view” diagram.

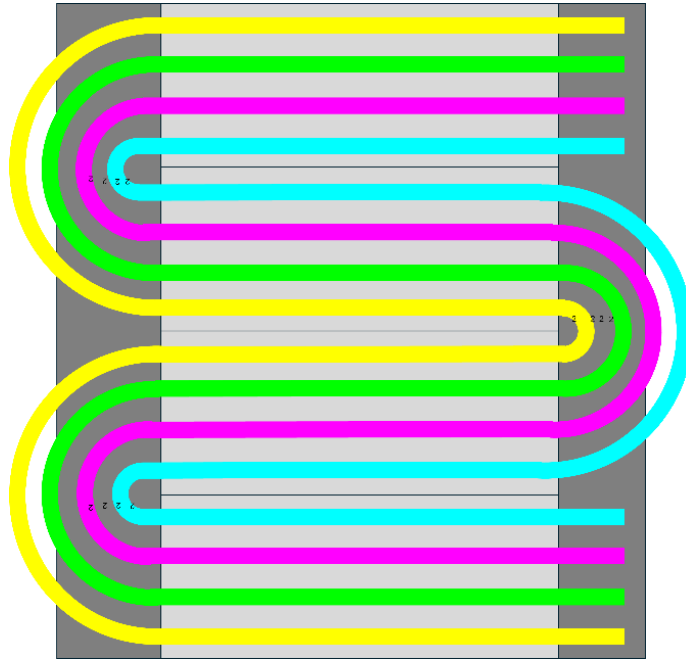

## CARE INSTRUCTIONS



Do not iron



Drip dry only

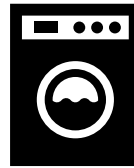

Machine washable



No bleach or strong cleaners

- **Outer Cover** (Nylon / Spandex / PU / Polyester / Neoprene)
  - Machine washable to 60°C on normal cycle. Drip dry only. Do not Iron. Do not use bleach or other strong cleaners.
- **Incontinence Cover (if fitted)** (PU / Nylon / Spandex)
  - Machine washable to 60°C on normal cycle. Drip dry only. Do not Iron. Do not use bleach or other strong cleaners.
- **Cushion Air Pocket with Air Tubes**
  - The cushion Air Pocket with Air Tubes can be hand washed, or machine washed using normal detergents.
    - Do not remove the Air Tubes from the Air Pocket for washing.
    - Always place the Air Pocket inside a garment bag before washing.
    - Use the delicate cycle.
    - Max Washing Temperature 60°C / 140°F
  - Drip dry only.
  - Do not tumble dry.
  - Do not iron.
  - Do not use strong cleaners or bleach.
  - Only install covers if fully dry.

## TROUBLE SHOOTING

Concern	Solution
Cushion is bottoming out	<ol style="list-style-type: none"> <li><b>Check the Tubes:</b> Check inside the cushion to ensure all tubes contain air. Damaged tubes will appear flattened compared to undamaged ones, which can be identified without removing the tubes. Any deflated tubes will need to be replaced.</li> <li><b>Increase Quantity of Tubes:</b> If the tubes are undamaged, more tubes can be added to reduce the chance of bottoming out. Changes to the setup is the responsibility of the prescriber.</li> </ol>
Cushion is too firm	<ol style="list-style-type: none"> <li><b>Decrease quantity of Tubes:</b> Removing tubes can increase immersion into the cushion softening the feel. Changes to the setup is the responsibility of the prescriber.</li> </ol>
Forward slippage	<ol style="list-style-type: none"> <li><b>Contour Base / Adjustable Base:</b> For the Woven Air cushion, these optional Bases add a 17mm high pre-ischial shelf reducing pelvic migration.</li> <li><b>Increase Quantity of Tubes:</b> Additional tubes can be added to the front zones of the cushion. Changes to the setup is the responsibility of the prescriber.</li> <li><b>Change the Cover Fabric:</b> Speak to your prescriber about different cover options.</li> </ol>
Lateral instability	<ol style="list-style-type: none"> <li><b>Check the Tubes:</b> Check inside the cushion to ensure all tubes contain air. Damaged tubes will appear flattened compared to undamaged ones, which can be identified without removing the tubes. Any deflated tubes will need to be replaced.</li> </ol>
Rearward Dispersion of air/ flattened appearance of tubes	<ol style="list-style-type: none"> <li><b>Optional "V" weave pattern.</b> Rearward dispersion of air may occur when the user is sitting forward on the cushion and may not be encompassing the whole surface area. Instead of the tubes weaving in a "W" configuration through 4 pockets, tubes can be folded at the centre "oval" position, and pairs of tubes can be woven through 2 pockets (forming a "V" configuration). This limits the dispersion of air. (see page 14). Changes to the setup is the responsibility of the prescriber.</li> </ol>
Cushion is too comfortable	<ol style="list-style-type: none"> <li><b>Enjoy!!</b></li> </ol>

**Ignite**

**SPLASH**

**Dreamline**

WHEELCHAIR SEATING

**Woven Air**

**snooza**



**Quality Assurance**

*Rolapal Ltd is an ISO 9001, 14001 & 45001 certified company!*

# Dreamline

## WHEELCHAIR SEATING

by

# ROLAPAL



Dr Dreamline

Check out our "How to"  
Videos Pages

Manufactured By:



**ROLAPAL Ltd**

14 Marphona Crescent, Takanini 2105 Auckland, New Zealand

Email: [info@rolapal.co.nz](mailto:info@rolapal.co.nz)

Website: [www.rolapal.co.nz](http://www.rolapal.co.nz)

EC

REP

BEO MedConsulting Berlin GmbH

Helmholtzstraße 2–9, D-10587 Berlin

