



WHEELCHAIR LATERALS











USER MANUAL

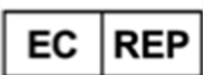

CONTENTS

	Page
Included in this package	4
Diagrams	5
Transport warning instructions	6
Installation & Occupant Safety Warnings	8
Intended use	8
Risks Identified Disclaimer	8
Product Life expectancy	9
Guarantee	9
Installation instructions	10
Using the Laterals	10
Care instructions	10

SYMBOLS

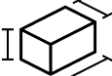
	Identifies products that meet the requirements of Regulation 2017/745 / EU on medical devices		Batch code
	Indicates that a product is a medical device		Catalogue number
	Shows the manufacturer of the medical device		Date of manufacture
	WC20 & ISO7176-19 certified for forward facing use in a motor vehicle		Authorized representative in the European Community
	Product weight (kgs)		Consult instructions for use
	Max User Weight (kgs)		Warnings
	Product Dimensions		

PAD OPTIONS

Straight



Curved



Anterior Support



Teardrop



BRACKET OPTIONS

Fixed



DFL

Fixed Angle-adjustable



DFLA

Swing-away



DSALL/R

Extended Swing-away

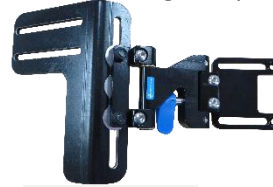

DSALLRL/R

Pivot Swing-away



DSALPL/R

Extended Pivot Swing-away



DSALLRPL/R

Clamp-on Swing-away



DSALCLL/R

Clamp-on Pivot Swing-away





DALCPL/R

LATERAL PAD CODES

	X-SML	SML	MED	LGE
STRAIGHT LATERAL PAD ONLY	DLPPXSML	DLPPSSML	DLPPSMED	DLPPSLGE
CURVED LATERAL PAD ONLY	DLPPCXSM	DLPPCSML	DLPPCMED	DLPPCLGE
ANTERIOR SUPPORT LATERAL PAD ONLY	-	DLPPASML	DLPPAMED	DLPPALGE
TEARDROP LATERAL PAD ONLY	-	DLPPTDSML	DLPPTDMED	DLPPTDLGE

WEIGHTS & DIMENSIONS

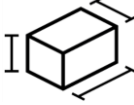
ITEM	 Kg		
Lateral Bracket	0.45	136	15cm x 24cm x 6cm
Lateral Pad	0.16	136	18cm x 23cm x 3cm

INCLUDED IN THIS PACKAGE



Lateral Pad x 1



Lateral Bracket x 1



Lateral Pivot Clamp Sections x 2 (pivot laterals only)

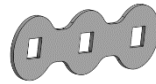

Fixing Plate x 1



M6 x 25mm Coach Bolt x 2



M6 Nyloc Nut x 2

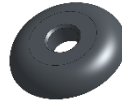

Large Aluminium Washer x 2

DIAGRAMS

Fig 1

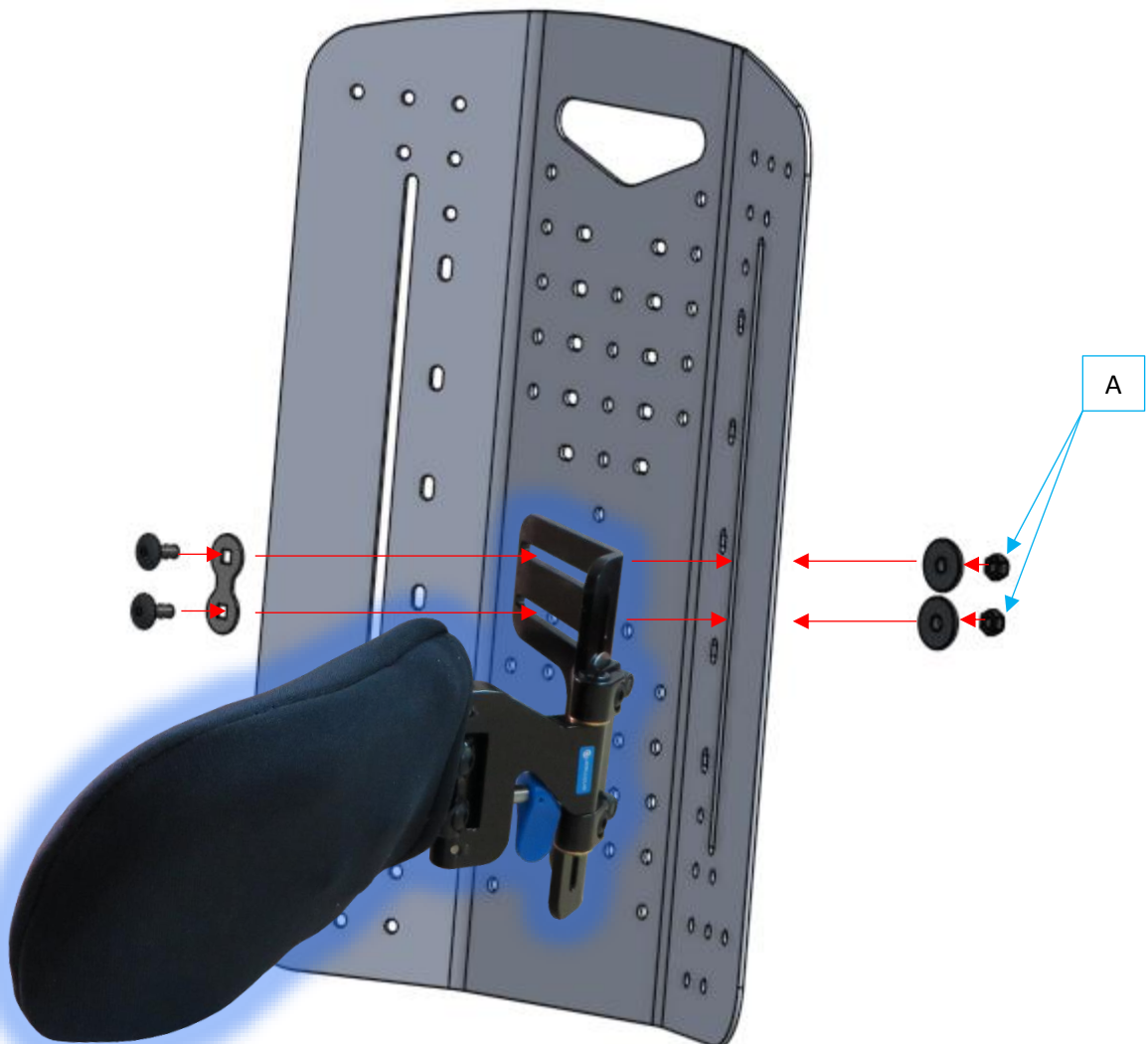

Fig 2

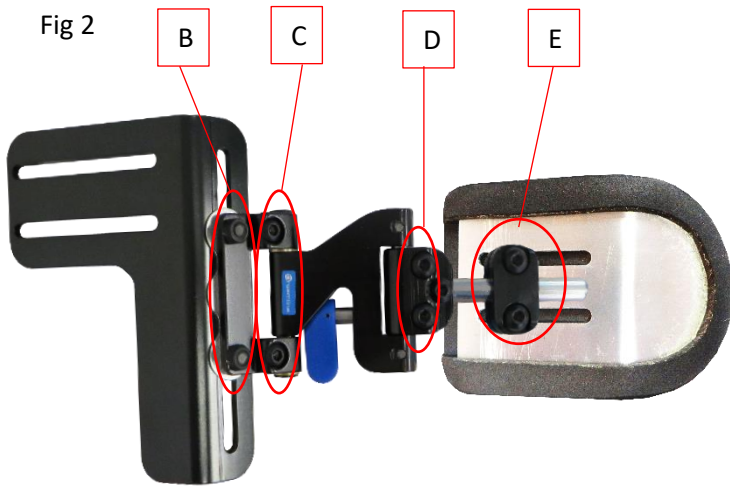

Fig 3



Fig 4

▨ Preferred Zone
 ▨ Optional Zone

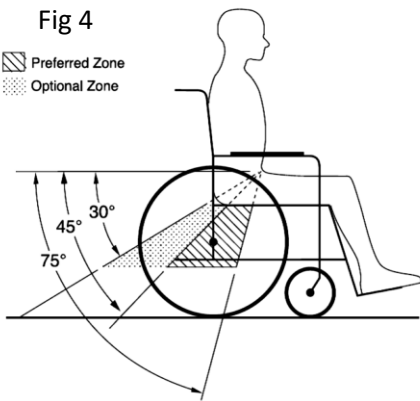

Fig 5



Fig 6

Pelvic-belt restraints should make good contact with the front and sides of the body near the junctions of the thighs and pelvis and against the hips

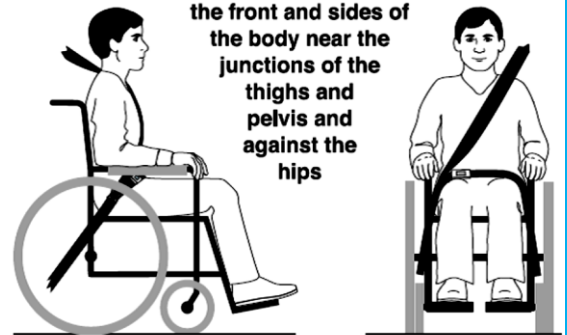
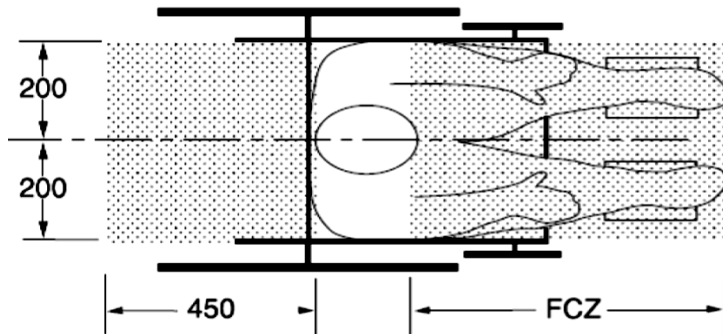

Fig 7

TOP VIEW



NOTES: The rear clear zone is measured from the rearmost point on an occupant's head. The front clear zone is measured from the frontmost point on an occupant's head.

Seated head height (HHT) ranges from about 1200 mm for a small adult female to about 1550 mm for a tall adult male.

Fig 8

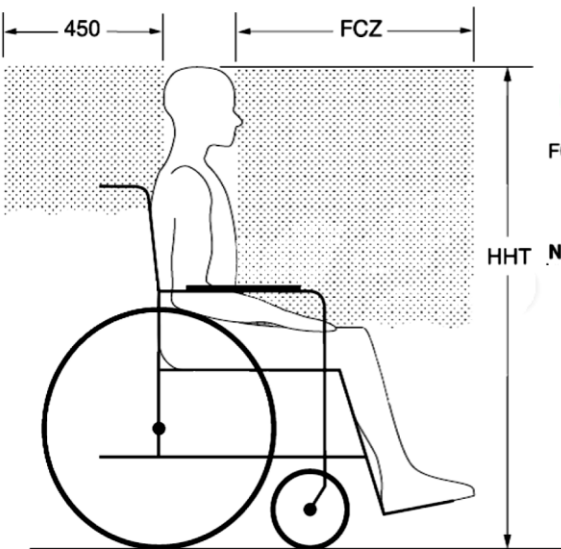

SIDE VIEW

Recommended forward and rearward clear zones for wheelchair-seated occupants

NOTE The frontal clear zone may not be achievable for wheelchair-seated drivers.

FCZ = 650 mm with upper torso restraint
 = 950 mm with only pelvic restraint

NOTE: It is strongly recommended that both pelvic and upper-torso belts be used.



TRANSPORTATION WARNINGS

1. When transporting occupants on their wheelchairs inside motor vehicles, Dreamline Wheelchair Seating is designed only for use with wheelchair frames that have been successfully crash tested to the frontal-impact requirements of RESNA WC-42012, Section 19.
2. When used as a seat for the occupant inside a motor vehicle, Dreamline Wheelchair Seating must only be used on wheelchair frames that provide four securement points and pelvic belt anchor points that conform to the requirements of RESNA WC-4:2012, Section 19.
3. When the Dreamline seating system is used for occupancy inside a motor vehicle, it is designed specifically for wheelchairs that are forward facing inside the motor vehicle.
4. When the Dreamline Seating system is used for occupancy inside a motor vehicle it must only be used in accordance with the wheelchair manufacturer's instructions.
5. Back supports with adjustable recline angles should not be tilted back more than 30 degrees to the vertical during travel in vehicles unless necessary for the medical & postural needs of the occupant.
6. If the back support must be adjusted to an angle that is greater than 30 degrees to the vertical during travel in a motor vehicle, the upper shoulder belt anchor point should be adjusted rearward to maintain belt contact with the wheelchair occupant's shoulder and chest.
7. Wheelchair mounted rigid trays that are not specifically designed for use during travel in motor vehicles should be...
 - a. Removed and secured separately in the vehicle, or
 - b. Secured to the wheelchair so they will not break free in a crash and
 - i. Be positioned with a gap of at least 75mm (3") between the back edge of the tray and the wheelchair occupant's abdomen and/or chest so as not to interfere with proper belt restraint use, and
 - ii. Have energy absorbing padding placed between the back edge of the tray and the wheelchair occupant.
8. The use of a postural pelvic belt attached to the wheelchair base or seat frame is encouraged during travel, but these belts should be positioned so they don't interfere with the proper positioning of crashworthy belt restraints, and they should not be relied on for occupant protection in crash situations unless the postural belt has been designed to comply with, and perform to, the requirements of 4.6, 5.2, and 5.3 of RESNA WC-4:2012, Section 19 (i.e. with WC19).
9. People who use wheelchairs should transfer to the vehicle seat and use the vehicle installed occupant-restraint systems when this is feasible.
10. There must be sufficient clear space around the wheelchair for the wheelchair occupant and other occupants inside the vehicle to remain safe during travel. Recommendations are made in Fig 7, 8 for Head Height (HHT) and rear space of 450mm from the users back with a Frontal Clear Zone (FCZ) of 650mm with pelvic / upper torso restraint or 950mm if there is only a pelvic restraint. This may not be achievable for wheelchair seated drivers. Wheelchair seated drivers must comply with the modified vehicle's and transport approved restraint manufacturer's instructions.

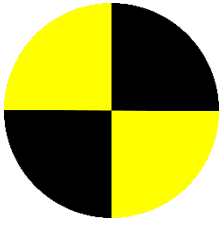

TRANSPORTATION INSTRUCTIONS

The following components have all been tested & are both WC20 & ISO7176-19 certified for forward facing transportation with an occupant in a motor vehicle; Quick-release Seat Pan, All Dreamline Cushions, Dreamline Contour, Support, S3 & STX Backrests, Quick-release swing-down Hip guides & Armrests, Swing-down Pommel, both fixed & Swing-away laterals & Dreamline Axis Headrests.

Dreamline Wheelchair Seating fully complies with RESNA WC-4:202, Section 20 & when used with a wheelchair frame which complies with RESNA WC-4:2012, Section 19 if used as a transportation device for an occupant in a motor vehicle.

Dreamline Wheelchair Seating has been designed to accommodate the proper use of vehicle anchored belt restraints with a rating of 16 out of 16 & pass level of A+ (Excellent): a) ease of properly positioning vehicle anchored belt restraints on the wheelchair passenger & b) the degree to which proper positioning of the belt restraints can be achieved.

1. The pelvic belt transport approved restraint should be worn low across the front of the pelvis near the junctions of the pelvis and thighs.
2. The angle of the transport approved pelvic belt restraint should be between 30 degrees to 75 degrees relative to the horizontal and ideally between 45 degrees to 75 degrees to the horizontal as shown in Fig 4.
3. The transport approved belt restraint buckle of three-point belt restraints should be placed in contact with the occupant's body and away from wheelchair components & should not be routed outside of the wheelchair wheels or over the wheelchair arm supports (Fig 5,6).
4. The junction of the shoulder belt & the pelvic belt of the transport approved three-point belt restraint should be located near the hip opposite the shoulder over which the diagonal belt crosses and not near the midline of the occupant (Fig 6).
5. Upper torso transport approved belt restraints should fit directly over, and in contact with, the middle of the shoulder (Fig 6)
6. Transport approved belt restraints should be adjusted to fit as snugly as possible, consistent with user comfort.
7. Transport approved belt restraints should not be worn twisted in a manner that reduces the area of contact of the belt webbing with the occupant.

ISO 16840-4

Dreamline Wheelchair Seating has been tested to comply with the requirements of ISO16840-4. Dreamline Wheelchair Seating will only comply if the corresponding wheelchair frame complies with the requirements of ISO7176-19. The frame must include anchorage points which comply with the requirements of ISO7176-19. Dreamline Wheelchair Seating have been designed and tested for forward facing travel in a motor vehicle. Dreamline Wheelchair seating will only comply if the corresponding wheelchair tie-down & occupant restraint system (WTORS) complies with ISO 10542-1.



INSTALLATION & OCCUPANT SAFETY

- Dreamline Laterals must only be installed and configured by a qualified seating therapist or technician.
- Fully read the instructions before installing the Lateral.
- Do not use this lateral if it has become loose, broken, not in the desired position, or not working properly.
- Always ensure the lateral is locked in place before using.
- Do not position the laterals too high under the occupant's arms. Risk of pain and circulation reduction.
- Do not use if redness or pain develops in the region contacting the laterals.

INTENDED USE

This item is intended for persons with disabilities as a lateral support on a wheelchair seat. If there are any questions about product installation or compatibility with the wheelchairs, ROLAPAL customer service should be consulted.

Indication: Partially or permanently non-ambulatory limited to a sitting position

Contra-indication: None

CAUTION - RISKS IDENTIFIED

- The lateral can be positioned in many ways, take care to ensure the desired outcome is achieved for the occupant.
- Keep away from heaters and open flame – risk of fire.
- The lateral pad cover is removable for cleaning. Do not use if these are not correctly in place.

REPORTING OF INCIDENTS

All serious incidents occurring in relation to the product must be reported to ROLAPAL Ltd and your competent authority!

DISCLAIMER

Because of the infinite adjustability of the lateral support, Rolapal accepts no responsibility for the therapeutic outcome for the occupant. This is the responsibility of the seating therapist or technician.

REUSABILITY

The product is basically suitable for reuse. The reuse handover takes place after the product has been checked by the specialist trade.

SPECIAL STORAGE/HANDLING CONDITIONS

Do not store in environments above 50°. Do not store close to roofs to avoid heat. If not in use, please store in dust free environments.

PRODUCT LIFE EXPECTANCY

This item is expected to last between 2 – 5 years under normal use but this can change dramatically between users depending on the length of time in use, environment & weight of the user.

END OF LIFE RECYCLING

At the end of its useful life, all metal components are easily removed for recycling. Foam inner and cover are general waste disposal.

GUARANTEE

Dreamline Supports are manufactured to a very high standard and carry a guarantee against defects in materials and craftsmanship for a period of 18 months.

Any item found to be defective will be repaired or replaced at the discretion of Rolapal Ltd.

Goods must be returned to Rolapal Ltd for assessment and the new repaired or replaced item will be sent free of charge.

This guarantee does not cover items which are damaged from general “wear and tear”, misuse or negligence.

INSTALLATION INSTRUCTIONS

1. Attach the lateral bracket assembly to the front surface of the backrest shell. Insert the two coach bolts through the fixing plate, through the lateral attachment bracket, through the long slots in the backrest shell then slide on the two washers & tighten the nyloc nuts firmly as in Fig 1. Position the top of the lateral pad approximately 25mm (2finger spacings) down from the occupant's underarm. The distance between inside surfaces of the left and right laterals should be approximately 25mm wide than the overall chest width of the occupant.
2. **Adjusting the Height** – the height position of the lateral pad can be adjusted two ways. 1) Adjust the height at the point of attachment of the lateral bracket in the slots in the backrest shell by loosening the two nyloc nuts (Fig 1 – A) with a 10mm spanner and moving the lateral bracket vertically, or 2) for fine adjustment adjust, the height by loosening the 2 nyloc nuts (Fig 2 – B Extended laterals only).
3. **Adjusting the Width** - the width position of the lateral pad can be adjusted two ways. 1) Adjust the width at the point of attachment of the lateral bracket in the slots in the backrest shell by loosening the two nyloc nuts (Fig 1 – A) with a 10mm spanner and moving the lateral bracket horizontally & 2), the bracket may be moved laterally by loosening both (Fig 2 C & D) screws using a 4mm Allen Key to adjust the offset. This method can also adjust the anterior support angle of the pad.
4. **Adjusting the Depth** – The lateral pad may be moved forward and back to adjust the depth by loosening the 2 screws (Fig 2 – E) using a 4mm Allen key.
5. **Adjusting the Tilt** (pivot laterals only) – the tilt angle of the pad may be adjusted by loosening the two screws (Fig 2 – E) then pivoting the pad to the desired position using a 4mm Allen Key.

OPERATING THE SWING-AWAY RELEASE MECHANISM

Rotate the lever on the lateral mechanism (Fig 3 – F) & swing the lateral away. Swing the lateral back into position and it will lock automatically.

CARE INSTRUCTIONS

The outer cover is removable for washing. (Nylon / Neoprene)

- Warm machine washable
- Drip dry only.
- Do not iron.
- Do not use strong chemicals or bleach.

Do not allow the foam inner to become damp. If the foam inner accidentally becomes damp, air dry thoroughly before reinstalling the cover.

Dreamline

WHEELCHAIR SEATING



Posture adaptive

Pressure reactive

Performance effective

Ignite

SPLASH

Dreamline

WHEELCHAIR SEATING



Woven Air

snooza



Quality Assurance

Rolapal Ltd is an ISO 9001, 14001 & 45001 certified company!

Dreamline

WHEELCHAIR SEATING

by

ROLAPAL



Dr Dreamline

Check out our "How to"
Videos Pages

Manufactured By:



ROLAPAL Ltd

14 Marphona Crescent, Takanini 2105 Auckland, New Zealand

Email: info@rolapal.co.nz

Website: www.rolapal.co.nz

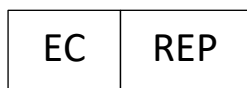

BEO MedConsulting Berlin GmbH

Helmholtzstraße 2–9, D-10587 Berlin

